

DATA SHEET

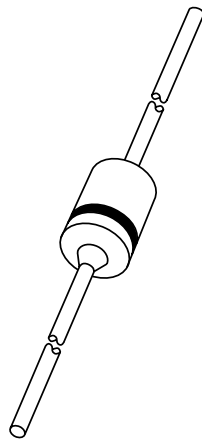

BYD11 series Controlled avalanche rectifiers

Product specification
Supersedes data of April 1996

1996 Sep 26

Controlled avalanche rectifiers

BYD11 series

FEATURES

- Glass passivated
- High maximum operating temperature
- Low leakage current
- Excellent stability
- Guaranteed avalanche energy absorption capability
- Available in ammo-pack.

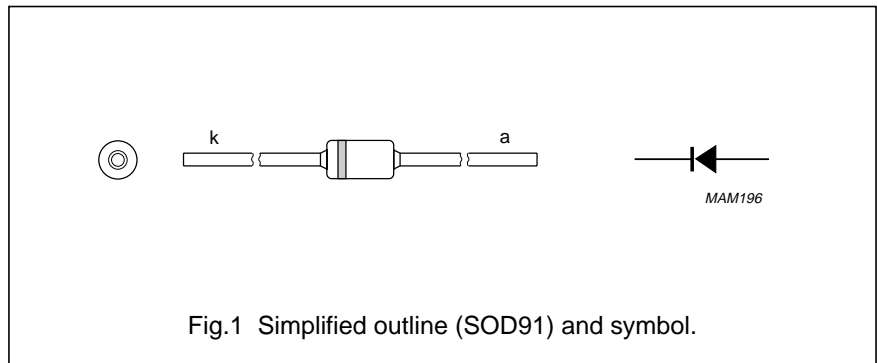

DESCRIPTION

Cavity free cylindrical glass package through Implotec™(1) technology.

This package is hermetically sealed and fatigue free as coefficients of expansion of all used parts are matched.

(1) Implotec is a trademark of Philips.

MARKING

TYPE NUMBER	MARKING CODE
BYD11D	11D
BYD11G	11G
BYD11J	11J
BYD11K	11K
BYD11M	11M

LIMITING VALUES

In accordance with the Absolute Maximum Rating System (IEC 134).

SYMBOL	PARAMETER	CONDITIONS	MIN.	MAX.	UNIT
V _{RRM}	repetitive peak reverse voltage				
	BYD11D		–	200	V
	BYD11G		–	400	V
	BYD11J		–	600	V
	BYD11K		–	800	V
V _{RWM}	crest working reverse voltage				
	BYD11D		–	200	V
	BYD11G		–	400	V
	BYD11J		–	600	V
	BYD11K		–	800	V
V _R	continuous reverse voltage				
	BYD11D		–	200	V
	BYD11G		–	400	V
	BYD11J		–	600	V
	BYD11K		–	800	V
	BYD11M		–	1000	V

Controlled avalanche rectifiers

BYD11 series

SYMBOL	PARAMETER	CONDITIONS	MIN.	MAX.	UNIT
$I_{F(AV)}$	average forward current	$T_{tp} = 55\text{ °C}$; lead length = 10 mm; averaged over any 20 ms period; see Figs 2 and 4	–	0.50	A
		$T_{amb} = 60\text{ °C}$; PCB mounting (see Fig.9); averaged over any 20 ms period; see Figs 3 and 4	–	0.37	A
I_{FSM}	non-repetitive peak forward current	$t = 10\text{ ms}$ half sinewave; $T_j = T_{j\text{ max}}$ prior to surge; $V_R = V_{RRM\text{ max}}$	–	10	A
P_{RSM}	non-repetitive peak reverse power dissipation	$t = 20\text{ }\mu\text{s}$ half sinewave; $T_j = T_{j\text{ max}}$ prior to surge	–	200	W
T_{stg}	storage temperature		–65	+175	°C
T_j	junction temperature	see Fig.5	–65	+175	°C

ELECTRICAL CHARACTERISTICS

$T_j = 25\text{ °C}$; unless otherwise specified.

SYMBOL	PARAMETER	CONDITIONS	MIN.	TYP.	MAX.	UNIT	
V_{Ftzt}	forward voltage	$I_F = 0.5\text{ A}$; $T_j = T_{j\text{ max}}$; see Fig.6	–	–	0.91	V	
		$I_F = 0.5\text{ A}$; see Fig.6	–	–	1.06	V	
$V_{(BR)R}$	reverse avalanche breakdown voltage	$I_R = 0.1\text{ mA}$					
			BYD11D	225	–	–	V
			BYD11G	450	–	–	V
			BYD11J	650	–	–	V
			BYD11K	900	–	–	V
			BYD11M	1100	–	–	V
I_R	reverse current	$V_R = V_{RRM\text{ max}}$; see Fig.7	–	–	1	μA	
		$V_R = V_{RRM\text{ max}}$; $T_j = 165\text{ °C}$; see Fig.7	–	–	75	μA	
t_{rr}	reverse recovery time	when switched from $I_F = 0.5\text{ A}$ to $I_R = 1\text{ A}$; measured at $I_R = 0.25\text{ A}$; see Fig.10	–	3	–	μs	
C_d	diode capacitance	$V_R = 0\text{ V}$; $f = 1\text{ MHz}$; see Fig.8	–	14	–	pF	

THERMAL CHARACTERISTICS

SYMBOL	PARAMETER	CONDITIONS	VALUE	UNIT
$R_{th\ j-tp}$	thermal resistance from junction to tie-point	lead length = 10 mm	180	K/W
$R_{th\ j-a}$	thermal resistance from junction to ambient	note 1	250	K/W

Note

- Device mounted on epoxy-glass printed-circuit board, 1.5 mm thick; thickness of copper $\geq 40\text{ }\mu\text{m}$, see Fig.9.
For more information please refer to the "General Part of associated Handbook".

Controlled avalanche rectifiers

BYD11 series

GRAPHICAL DATA

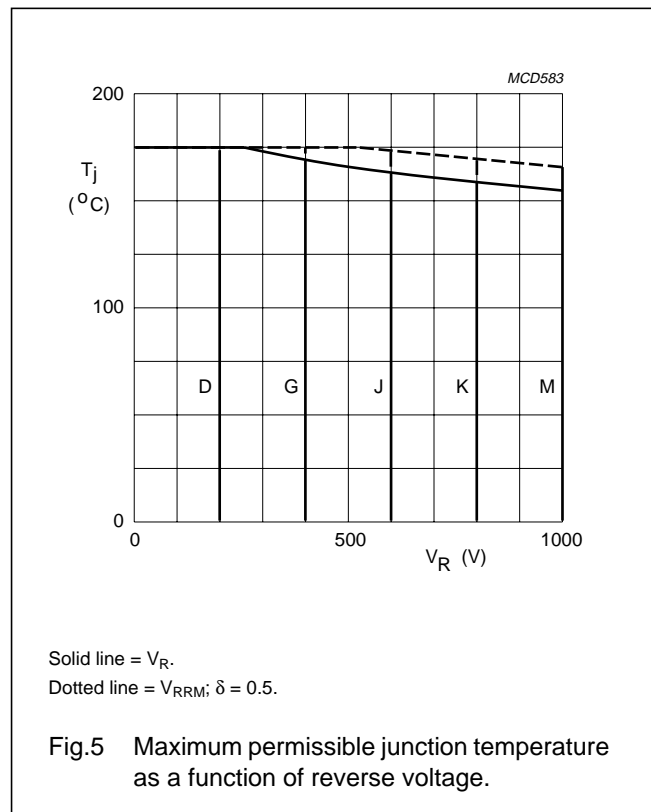
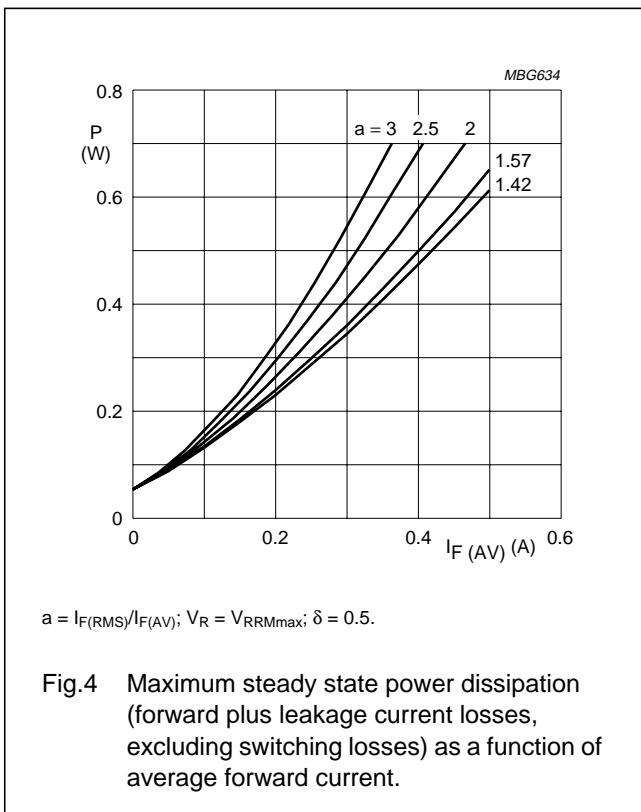
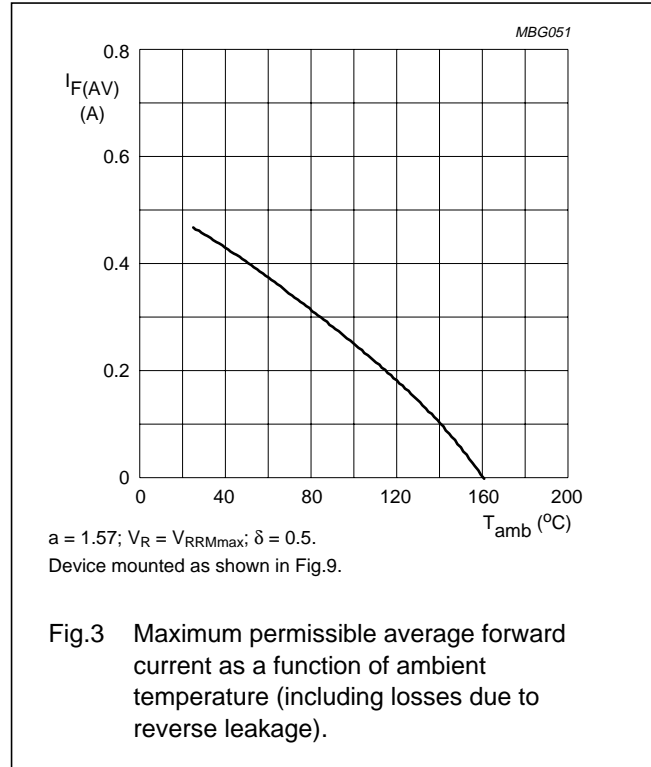
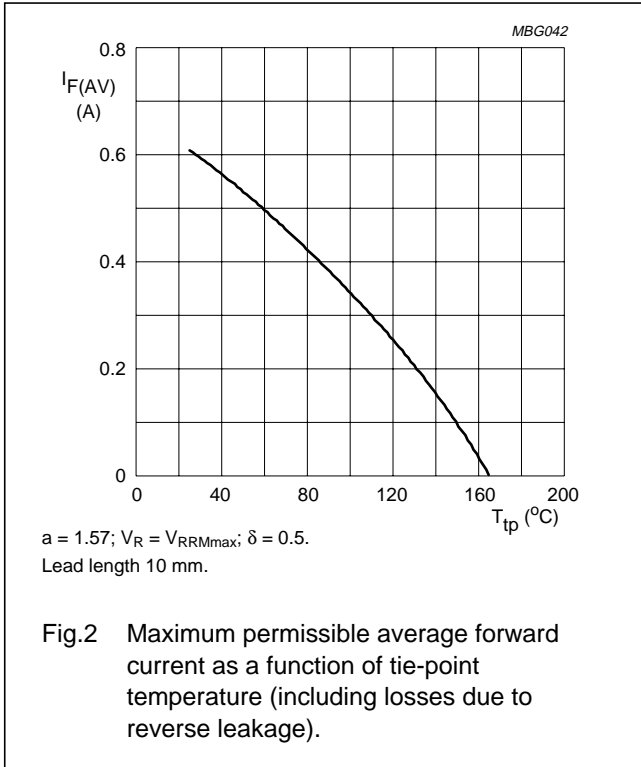

Controlled avalanche rectifiers

BYD11 series

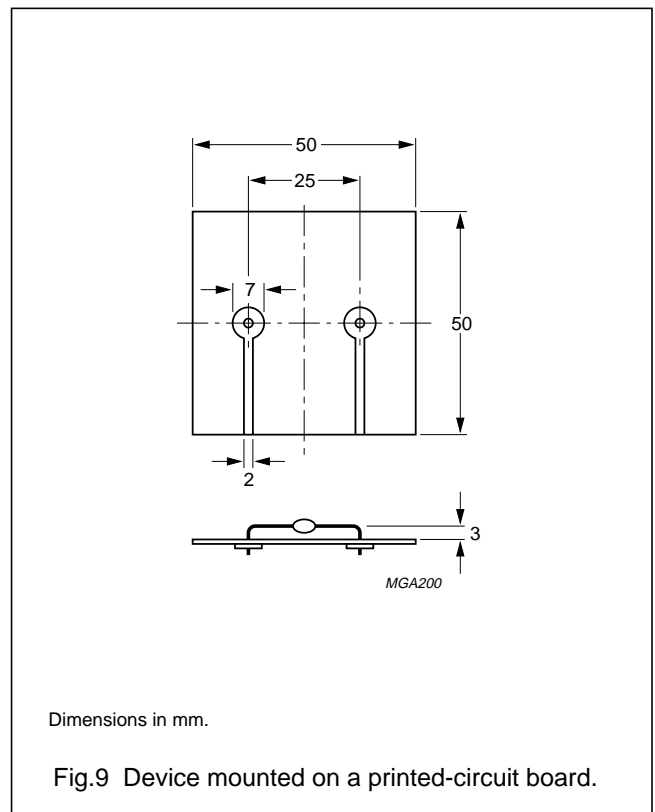
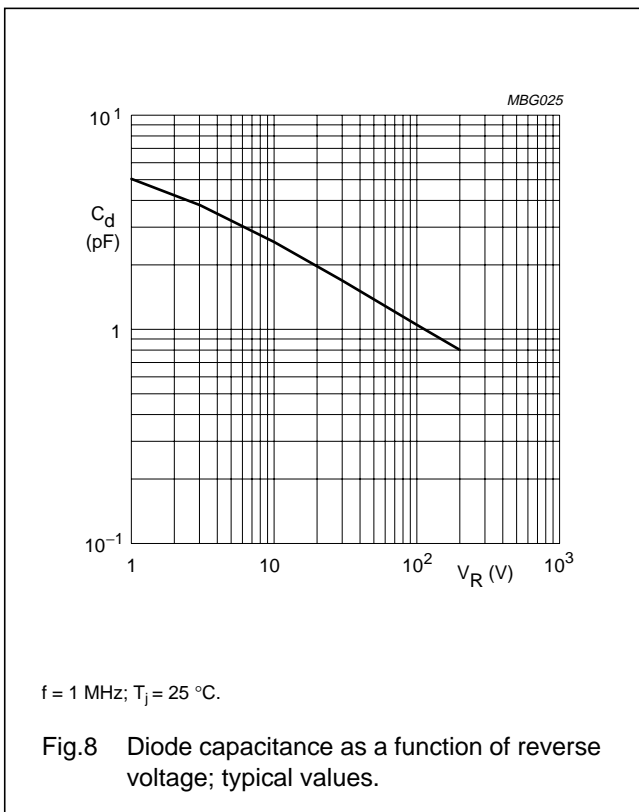
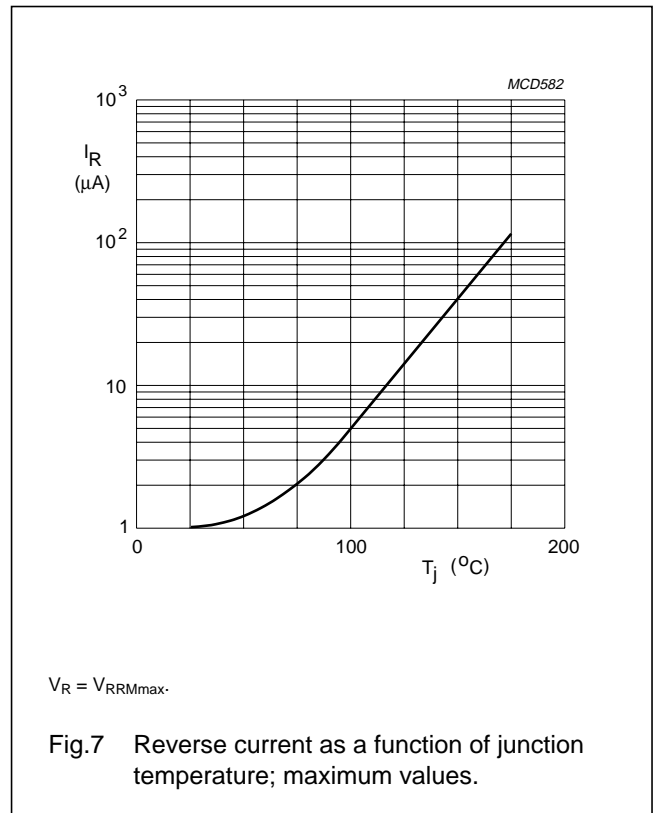
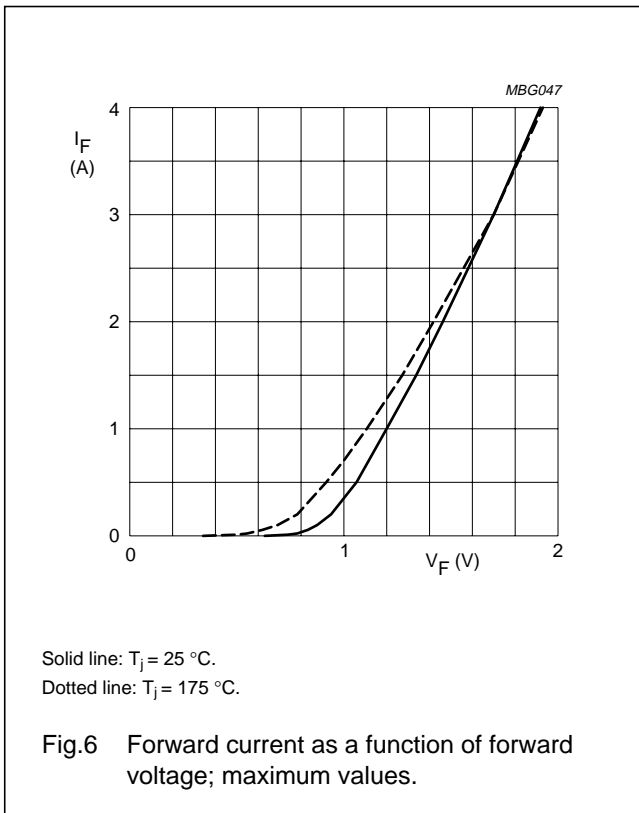

Controlled avalanche rectifiers

BYD11 series

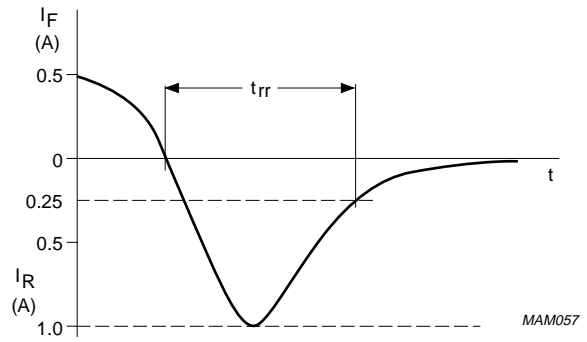
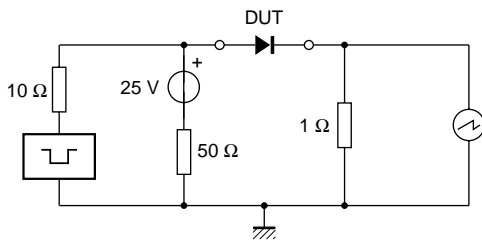

Input impedance oscilloscope: 1 M Ω , 22 pF; $t_r \leq 7$ ns.
Source impedance: 50 Ω ; $t_r \leq 15$ ns.

Fig.10 Test circuit and reverse recovery time waveform and definition.

Controlled avalanche rectifiers

BYD11 series

PACKAGE OUTLINE

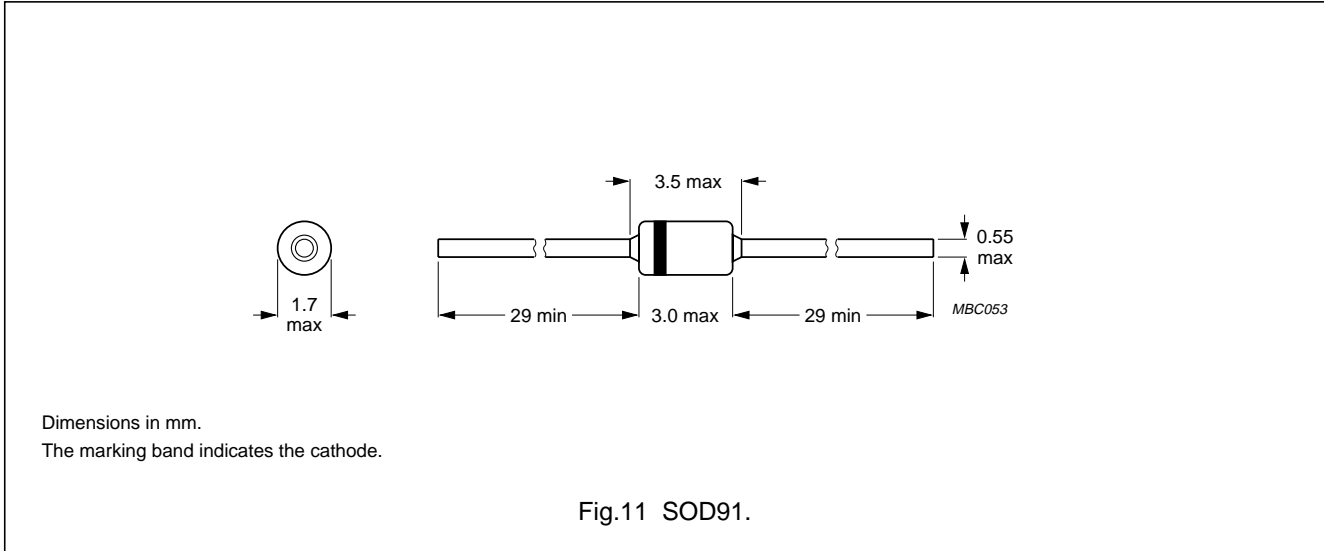

DEFINITIONS

Data sheet status	
Objective specification	This data sheet contains target or goal specifications for product development.
Preliminary specification	This data sheet contains preliminary data; supplementary data may be published later.
Product specification	This data sheet contains final product specifications.
Limiting values	
Limiting values given are in accordance with the Absolute Maximum Rating System (IEC 134). Stress above one or more of the limiting values may cause permanent damage to the device. These are stress ratings only and operation of the device at these or at any other conditions above those given in the Characteristics sections of the specification is not implied. Exposure to limiting values for extended periods may affect device reliability.	
Application information	
Where application information is given, it is advisory and does not form part of the specification.	

LIFE SUPPORT APPLICATIONS

These products are not designed for use in life support appliances, devices, or systems where malfunction of these products can reasonably be expected to result in personal injury. Philips customers using or selling these products for use in such applications do so at their own risk and agree to fully indemnify Philips for any damages resulting from such improper use or sale.